

1 KITCHEN - A
1/4" = 1'-0"

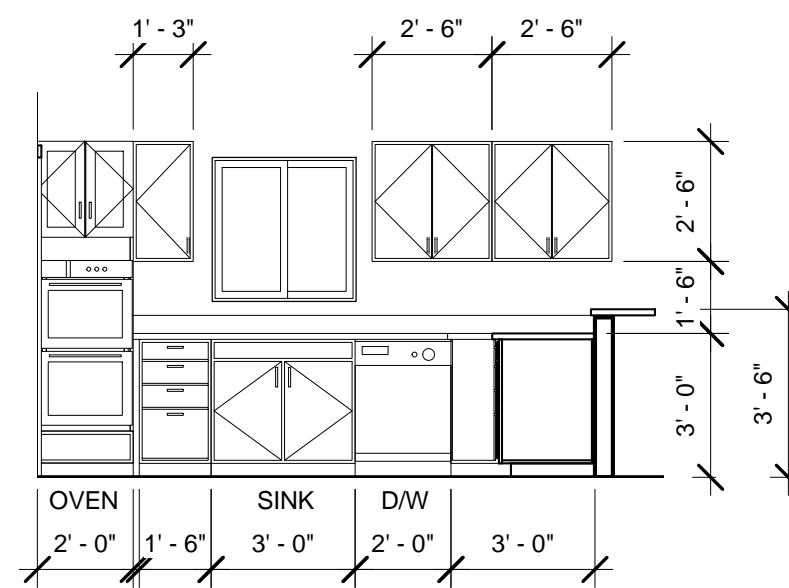

2 KITCHEN - B
1/4" = 1'-0"

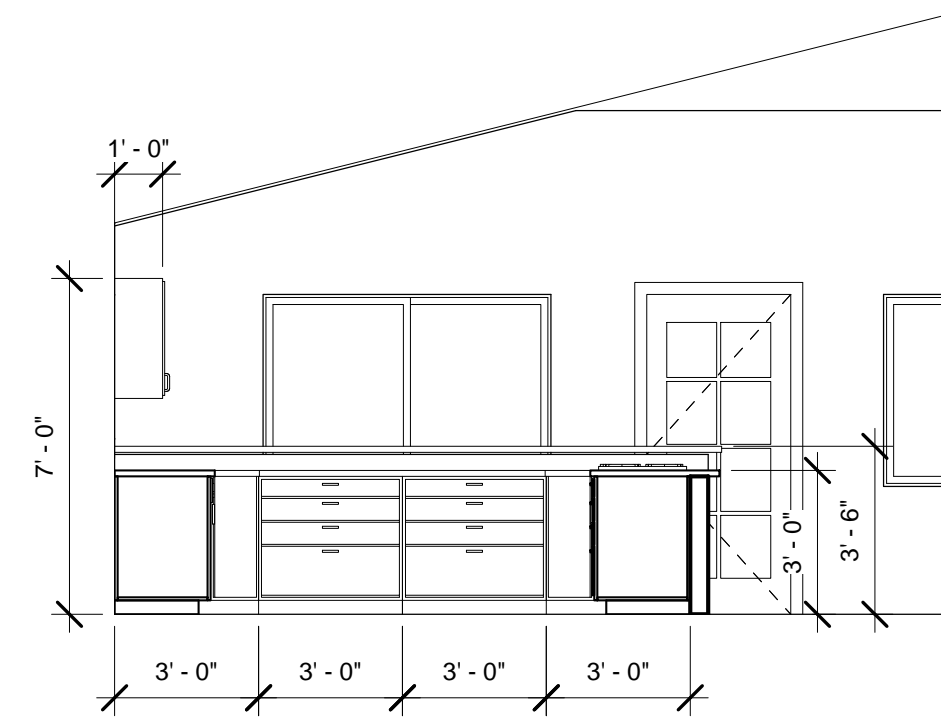

3 KITCHEN - C
1/4" = 1'-0"

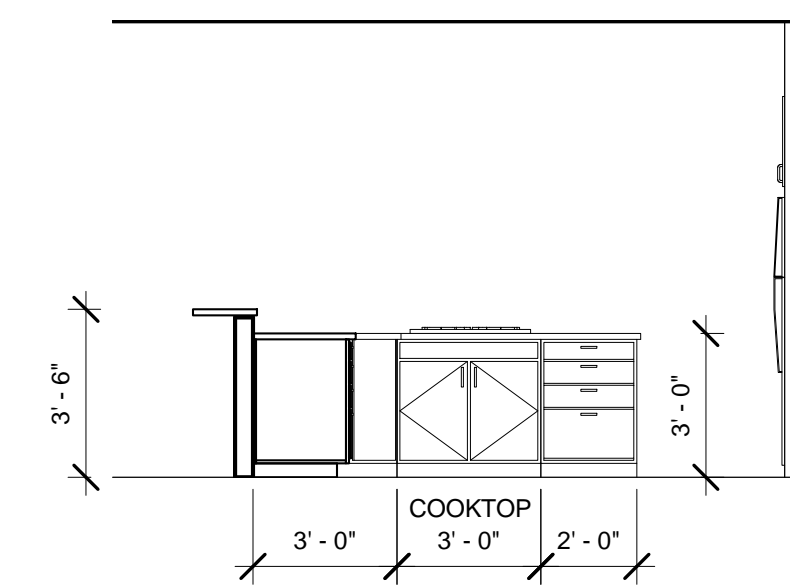

4 KITCHEN - D
1/4" = 1'-0"

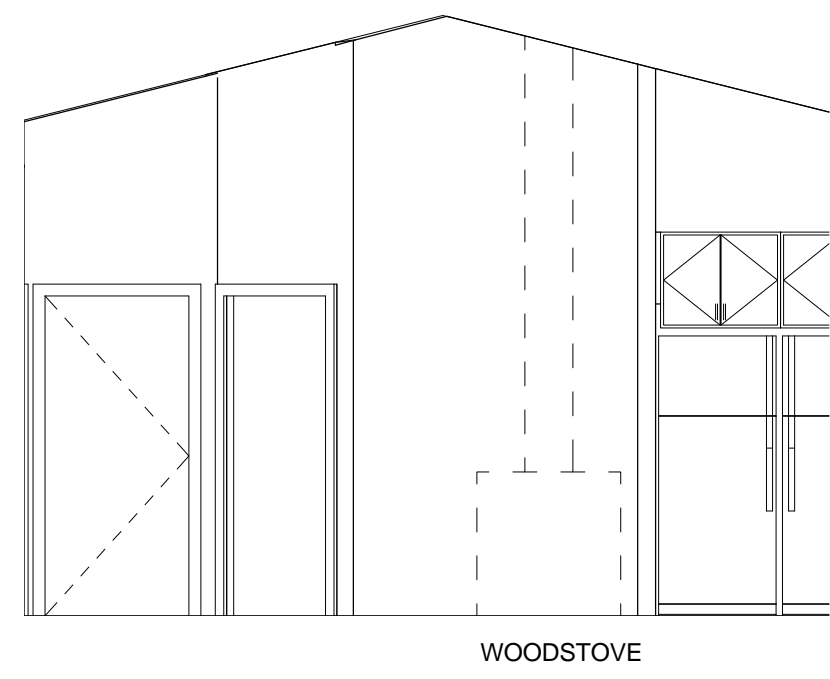

5 LIVING ROOM - A
1/4" = 1'-0"

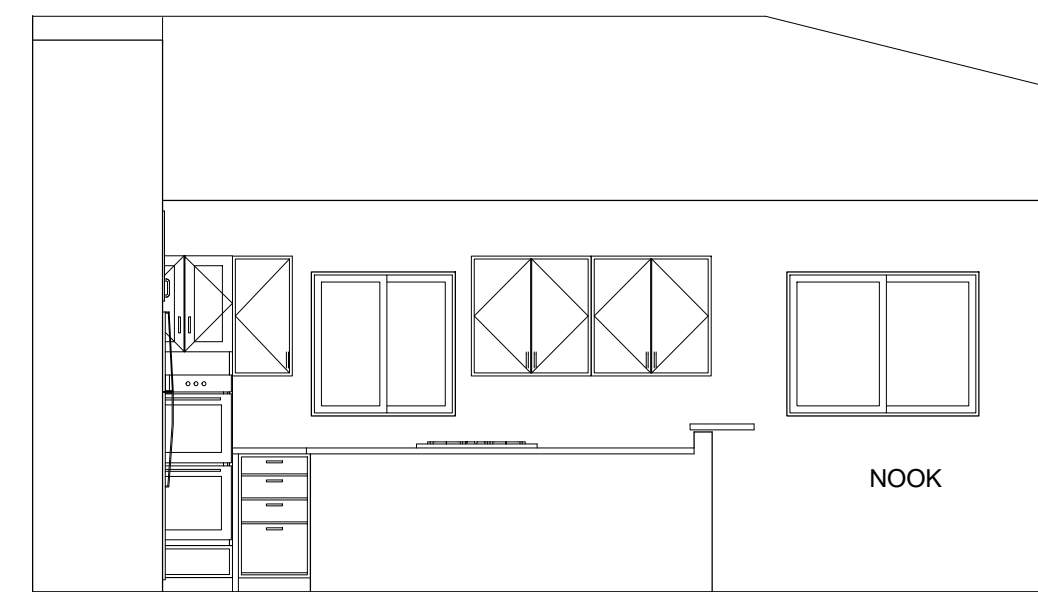

6 LIVING ROOM - B
1/4" = 1'-0"

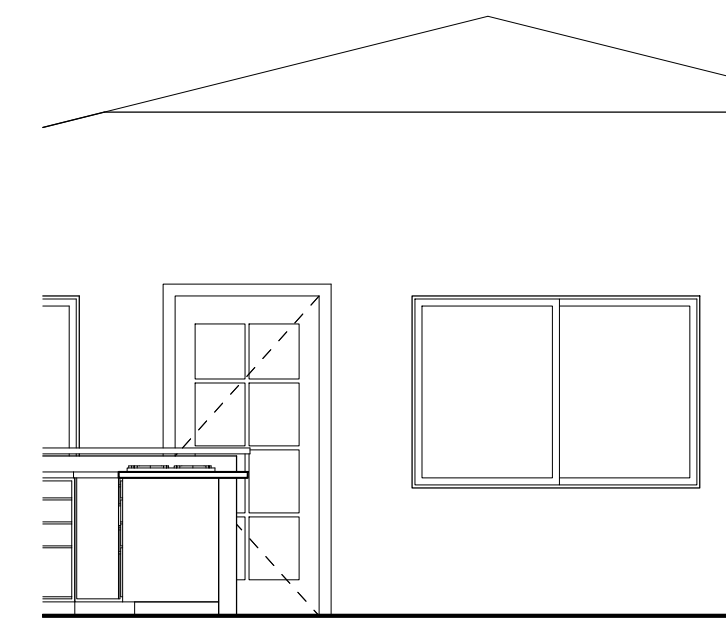

7 LIVING ROOM - C
1/4" = 1'-0"

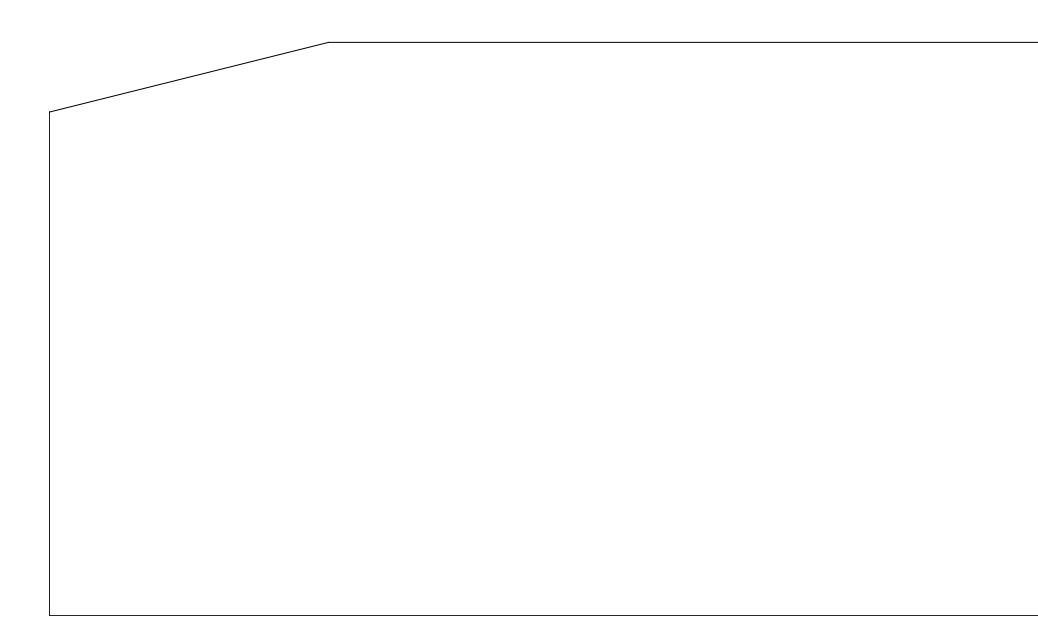

8 LIVING ROOM - D
1/4" = 1'-0"

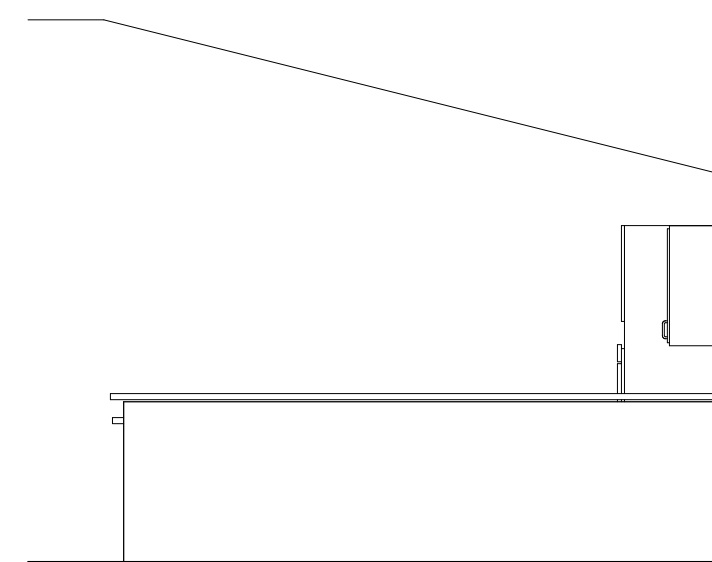

9 NOOK - A
1/4" = 1'-0"

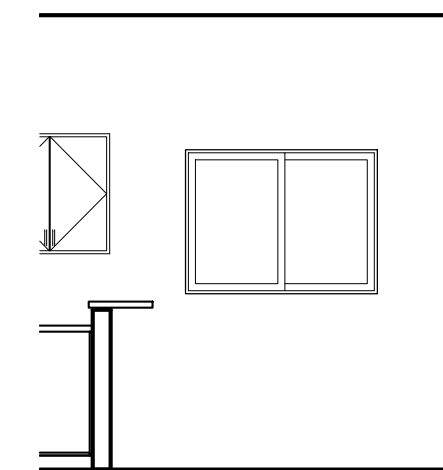

10 NOOK - B
1/4" = 1'-0"

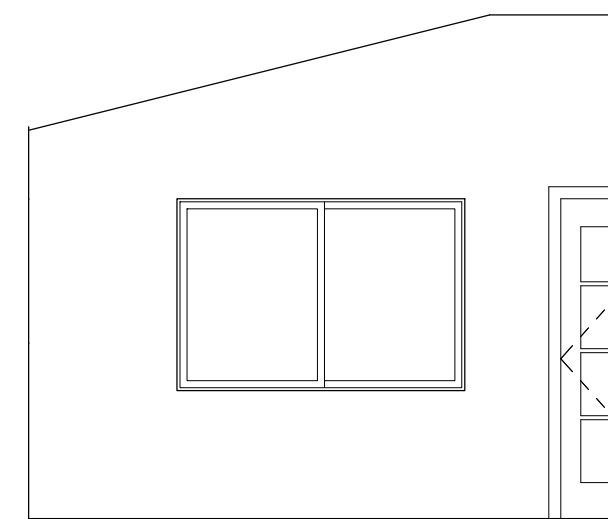

11 NOOK - C
1/4" = 1'-0"

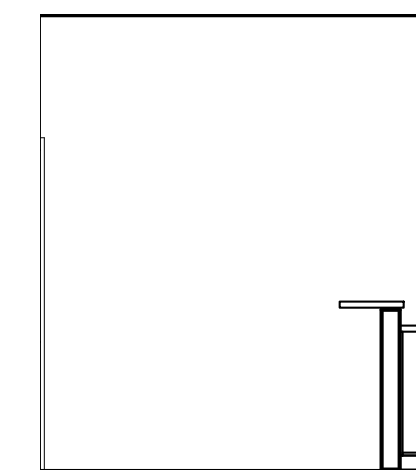

12 NOOK - D
1/4" = 1'-0"

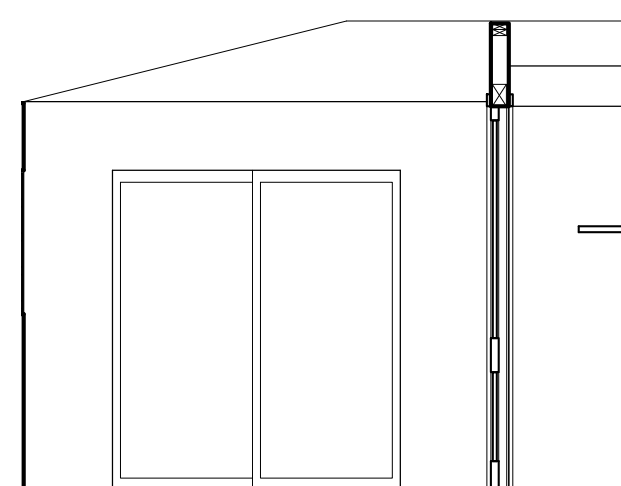

13 BEDROOM #2 - A
1/4" = 1'-0"

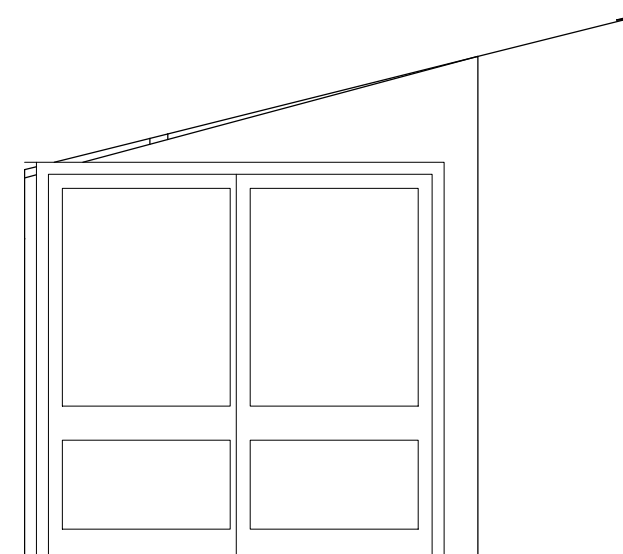

14 BEDROOM #2 - B
1/4" = 1'-0"

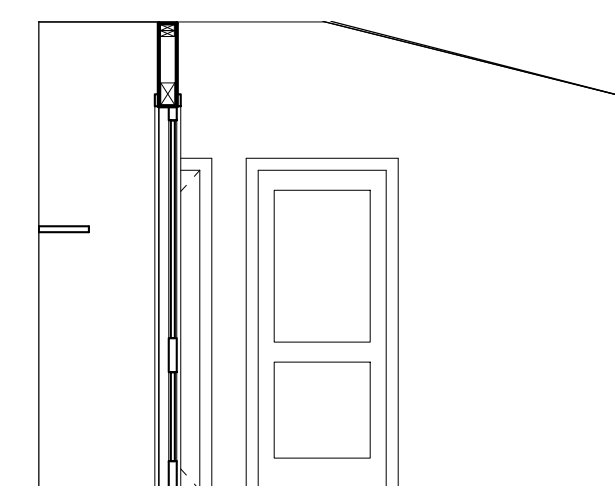

15 BEDROOM #2 - C
1/4" = 1'-0"

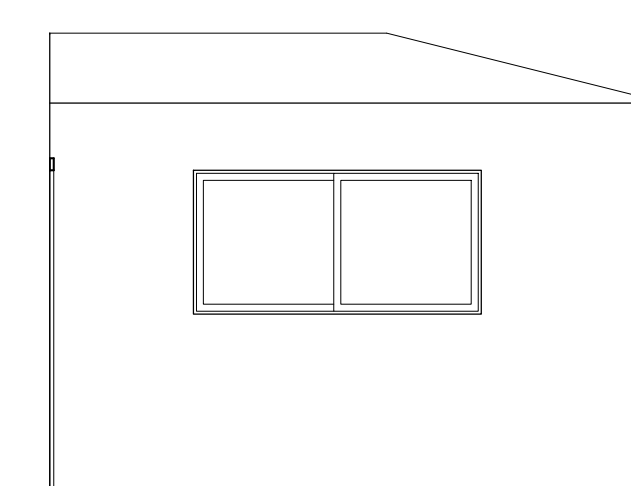

16 BEDROOM #2 - D
1/4" = 1'-0"

DATE
REV.
DESCRIPTION

SHEET TITLE: INTERIOR ELEVATIONS

PROJECT NO: 2006016
DATE: 9/12/06
DRAWN BY: RLA
SCALE: 1/4" = 1'-0"
SHEET NO.:

A4.1

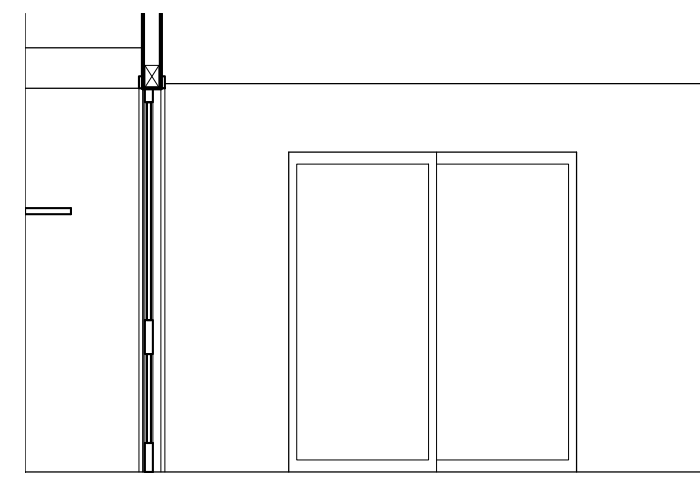

9 MASTER BEDROOM - A
1/4" = 1'-0"

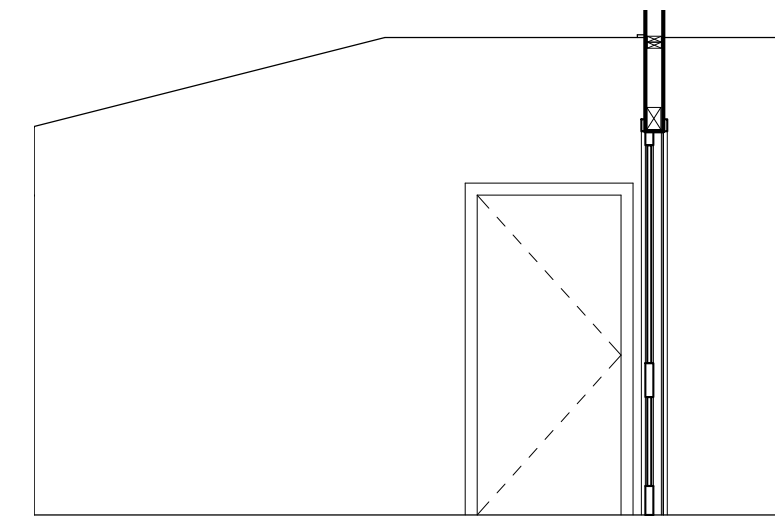

10 MASTER BEDROOM - B
1/4" = 1'-0"

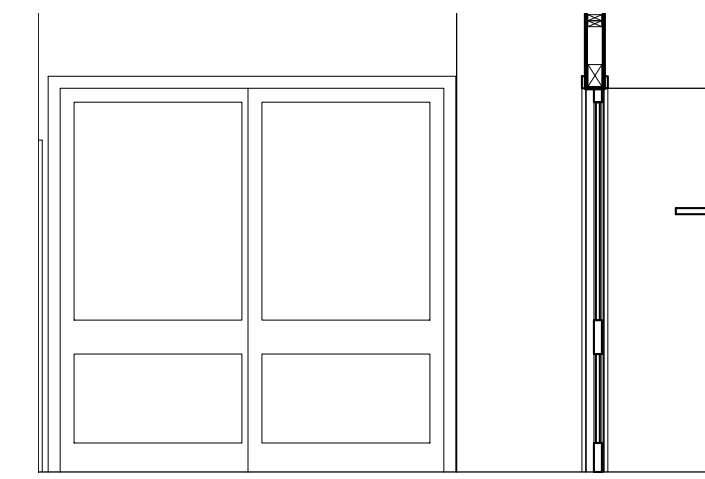

11 MASTER BEDROOM - C
1/4" = 1'-0"

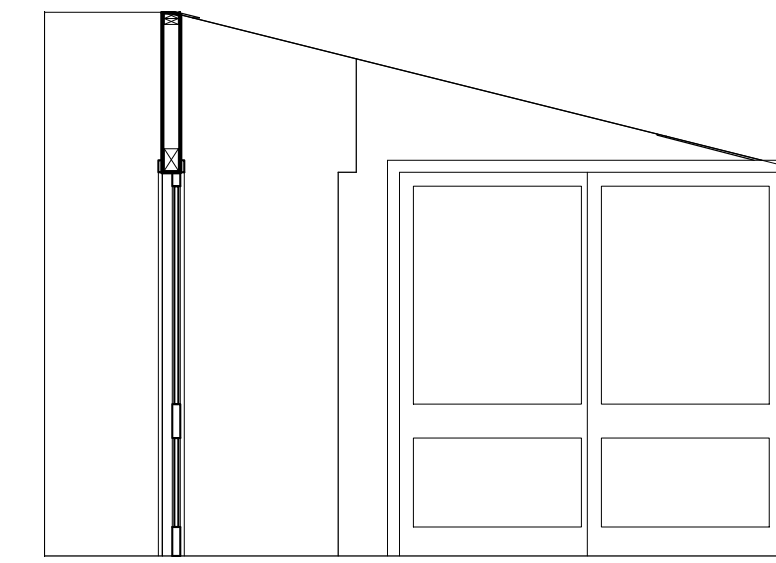

12 MASTER BEDROOM - D
1/4" = 1'-0"

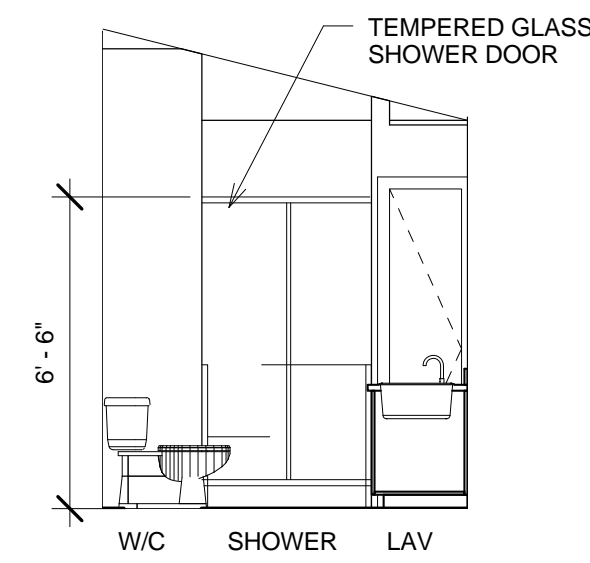

13 MASTER BATH - A
1/4" = 1'-0"

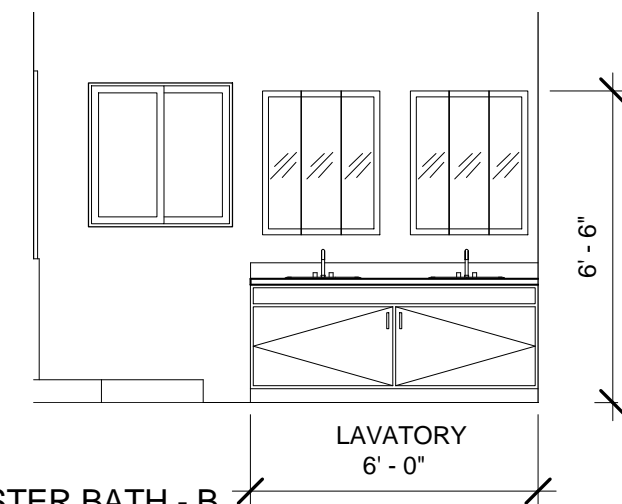

14 MASTER BATH - B
1/4" = 1'-0"

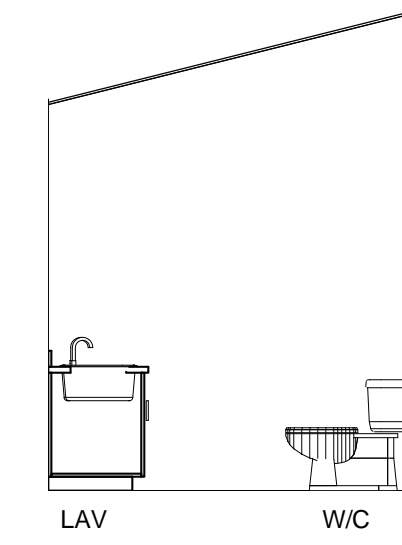

15 MASTER BATH - C
1/4" = 1'-0"

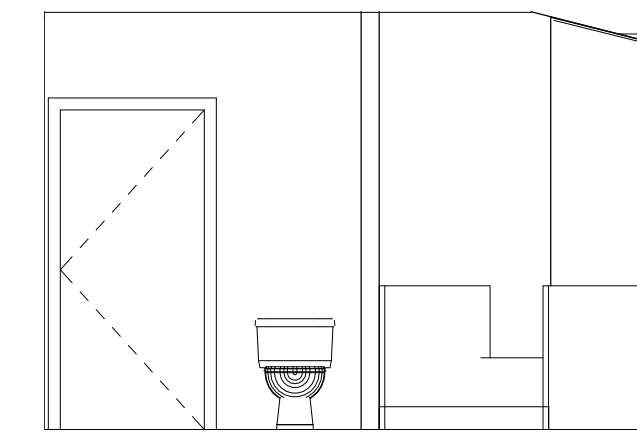

16 MASTER BATH - D
1/4" = 1'-0"

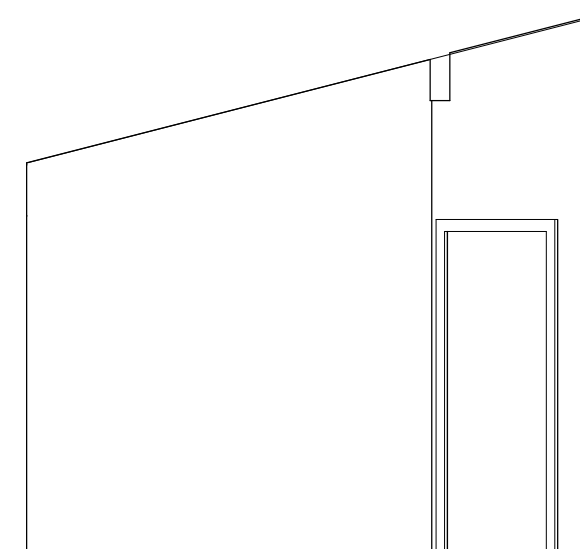

1 BEDROOM #3 - A
1/4" = 1'-0"



2 BEDROOM #3 - B
1/4" = 1'-0"

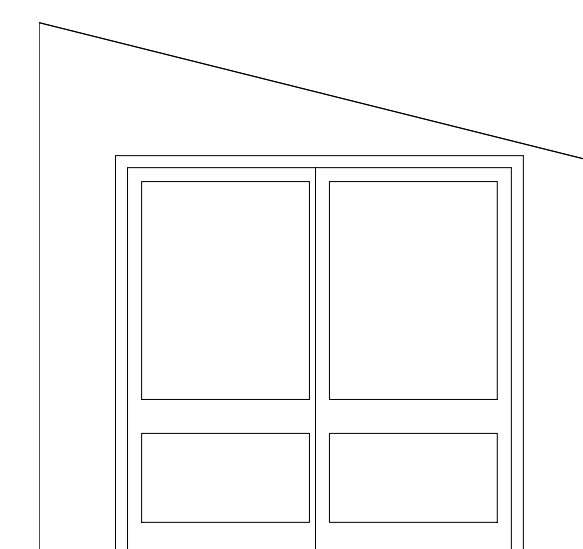

3 BEDROOM #3 - C
1/4" = 1'-0"

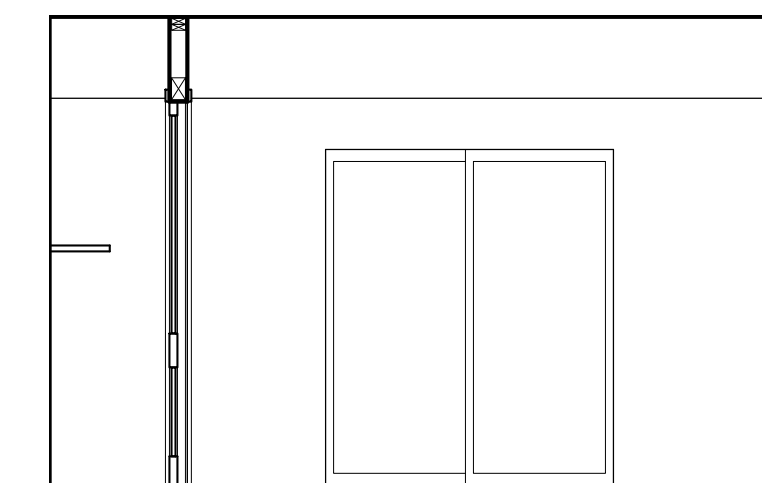

4 BEDROOM #3 - D
1/4" = 1'-0"

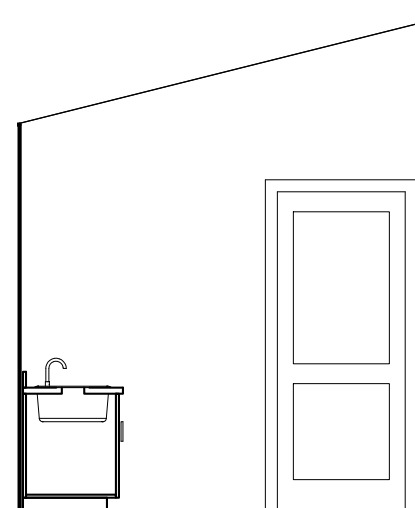

5 BATHROOM #2 - A
1/4" = 1'-0"

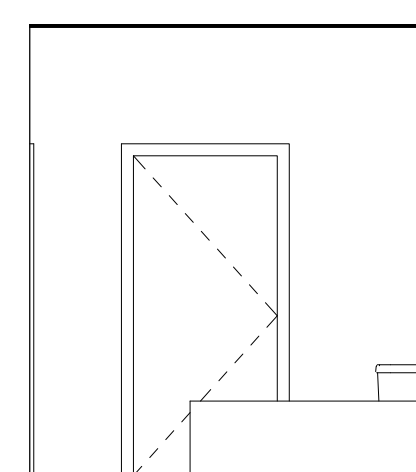

6 BATHROOM #2 - B
1/4" = 1'-0"

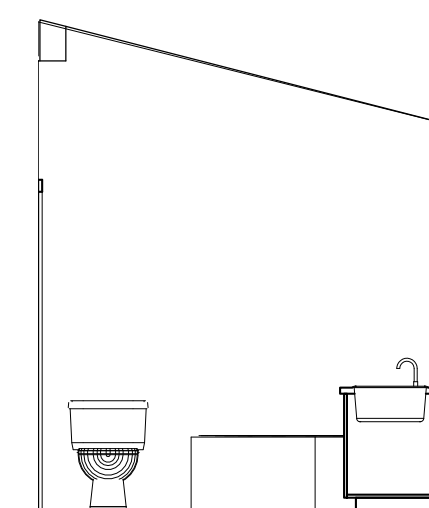

7 BATHROOM #2 - C
1/4" = 1'-0"

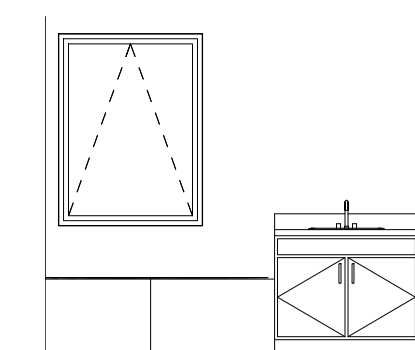

8 BATHROOM #2 - D
1/4" = 1'-0"

REV.	DESCRIPTION	DATE

SHEET TITLE: INTERIOR ELEVATIONS

PROJECT NO: 2006016
DATE: 9/12/06
DRAWN BY: Author
SCALE: 1/4" = 1'-0"
SHEET NO.:

A4.2

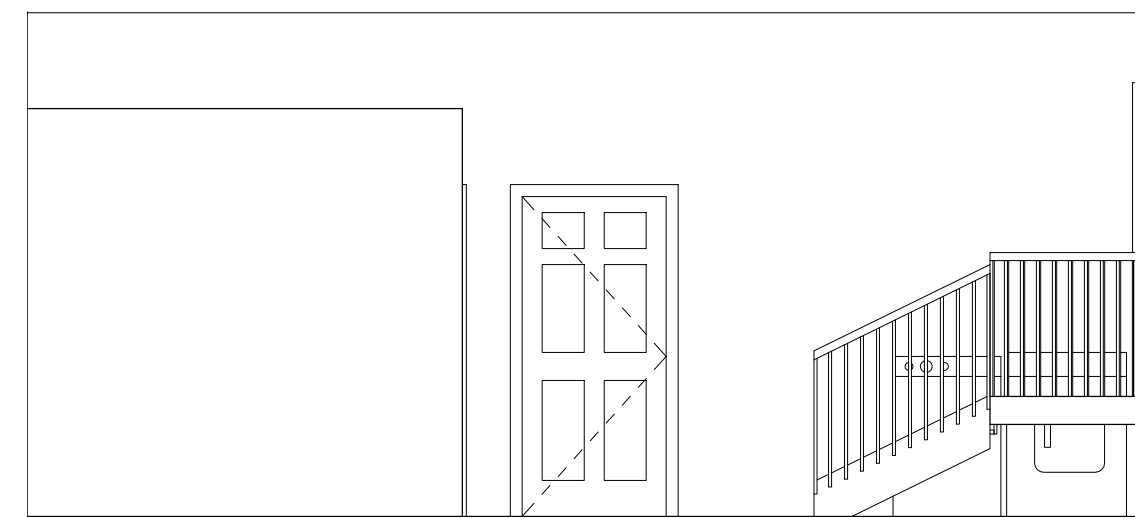

① GARAGE - A
1/4" = 1'-0"

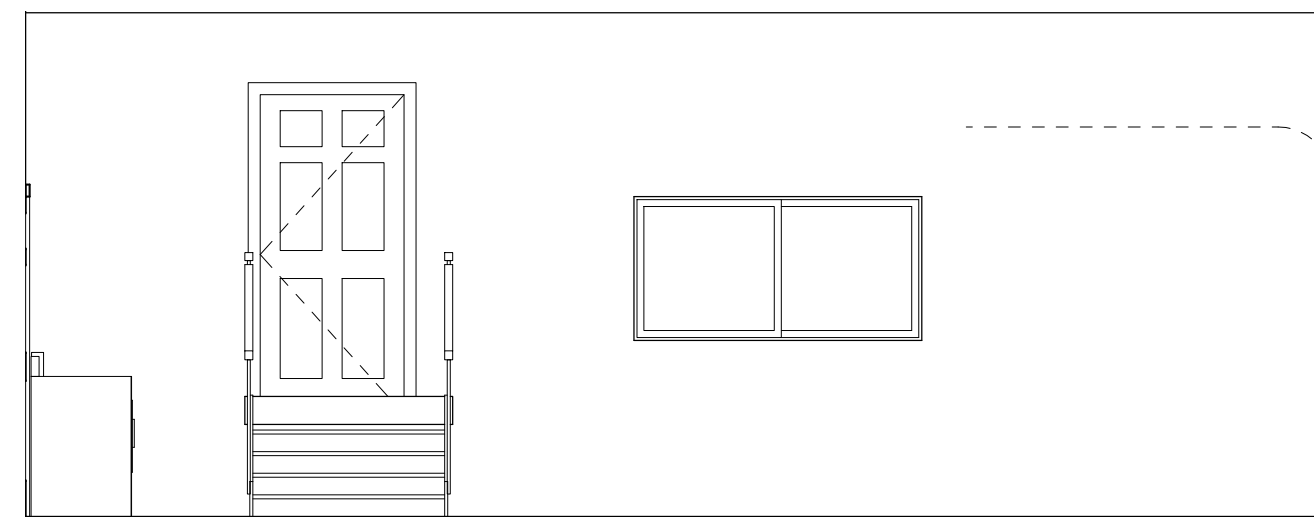

② GARAGE - B
1/4" = 1'-0"



③ GARAGE - C
1/4" = 1'-0"

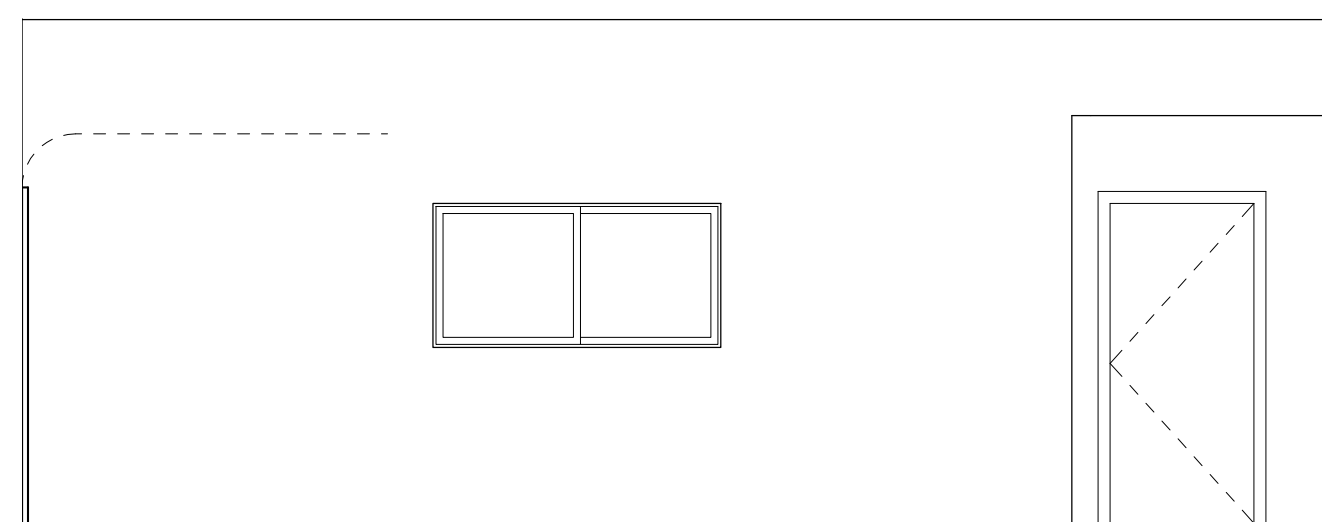

④ GARAGE - D
1/4" = 1'-0"

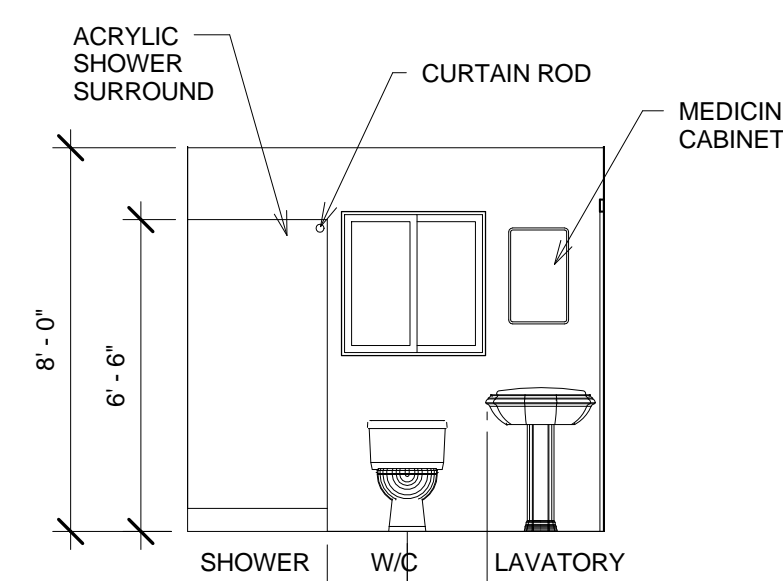

⑤ BATHROOM #3 - A
1/4" = 1'-0"

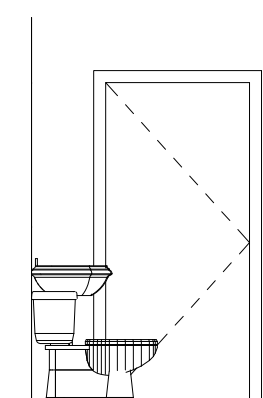

⑥ BATHROOM #3 - B
1/4" = 1'-0"

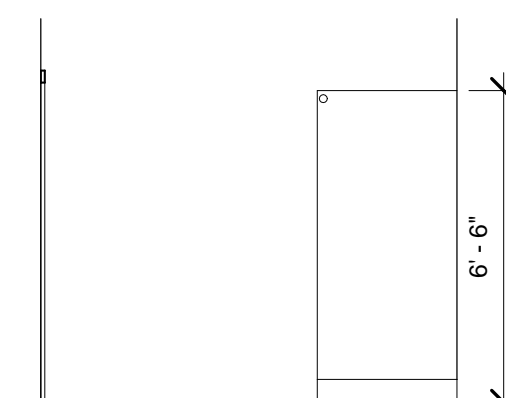

⑦ BATHROOM #3 - C
1/4" = 1'-0"

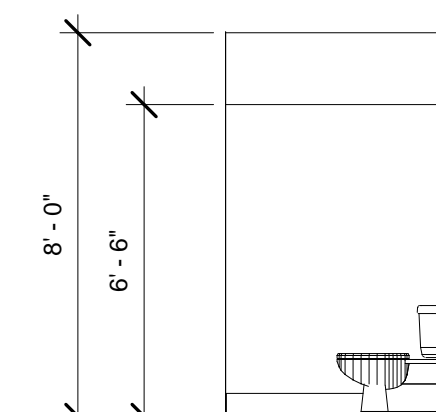

⑧ BATHROOM #3 - D
1/4" = 1'-0"

SHEET TITLE: INTERIOR ELEVATIONS

REV.	DESCRIPTION	DATE

PROJECT NO: 2006016
DATE: 9/12/06
DRAWN BY: Author
SCALE: 1/4" = 1'-0"
SHEET NO.: